



RED SWASTIKA SCHOOL

2022 MID-YEAR EXAMINATION

MATHEMATICS

Name : _____ ()

Class : Primary 4 / _____

Date : 11 May 2022

BOOKLET A

20 Questions

40 Marks

Duration of Paper : 1 hour 45 minutes

Note:

1. Do not open this Booklet until you are told to do so.
2. Read carefully the instructions given at the beginning of each part of the Booklet.
3. Do not waste time. If a question is difficult for you, go on to the next one.
4. Check your answers thoroughly and make sure you attempt every question.
5. In this booklet, you should have the following:
 - (a) Page 1 to Page 6
 - (b) Questions 1 to 20

Questions 1 to 20 carry 2 marks each. For each question, four options are given. One of them is the correct answer. Make your choice (1, 2, 3 or 4). Shade the correct oval (1, 2, 3 or 4) on the Optical Answer Sheet.

(40 marks)

-
- 1 In which of the following numbers does the digit '7' have the greatest value?
- (1) 20 751
 - (2) 47 609
 - (3) 60 857
 - (4) 82 973
- 2 $79\,508 = 70\,000 + \underline{\hspace{2cm}} + 500 + 8$
What is the missing number?
- (1) 9
 - (2) 90
 - (3) 900
 - (4) 9000
- 3 Which of the following are factors of 63?
- (1) 6 and 7
 - (2) 4 and 9
 - (3) 3 and 21
 - (4) 5 and 21
- 4 What is the quotient when 8096 is divided by 8?
- (1) 112
 - (2) 1010
 - (3) 1012
 - (4) 1120
- 5 Which of the following when rounded off to the nearest thousand is 20 000?
- (1) 19 499
 - (2) 19 932
 - (3) 20 504
 - (4) 20 987

6 Name the marked angle.

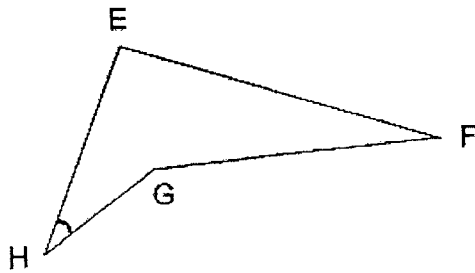

- (1) $\angle EFG$
- (2) $\angle FGH$
- (3) $\angle EHG$
- (4) $\angle FEH$

7 When you are facing north, what is the angle that you will turn through in a clockwise direction to face south-east?

- (1) 45°
- (2) 90°
- (3) 135°
- (4) 180°

8 Look at each pair of angle strips below. Which pair of angle strips shows a turn between a $\frac{1}{2}$ -turn and a $\frac{3}{4}$ -turn?

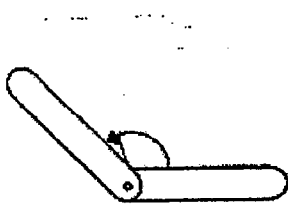

(1)

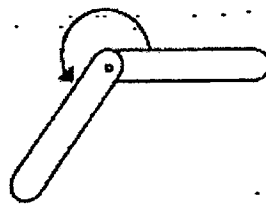

(2)

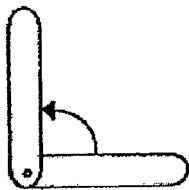

(3)

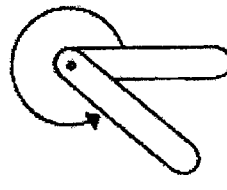

(4)

- 9 ABCD is a rectangle. Which of the following **incorrectly** describes the rectangle?

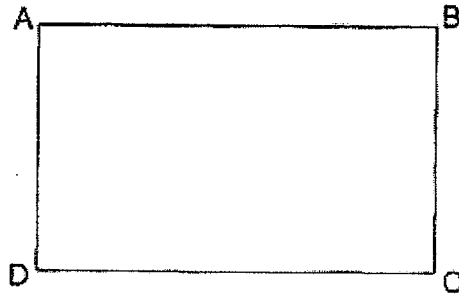

- (1) It has four right angles.
 - (2) It has four equal sides.
 - (3) Its opposite sides are equal.
 - (4) It has two pairs of parallel lines.
- 10 The time shown on the clock is _____.

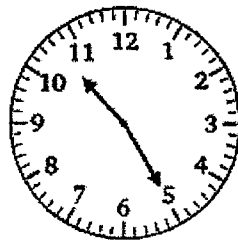

- (1) 5 minutes to 10
 - (2) 5 minutes past 10
 - (3) 25 minutes to 11
 - (4) 25 minutes past 10
- 11 In 98 580, what is the difference between the two values of the digit '8'?
- (1) 7200
 - (2) 7920
 - (3) 8000
 - (4) 8080
- 12 What is the sum of the first three multiples of 6?
- (1) 6
 - (2) 12
 - (3) 18
 - (4) 36

- 13 In the figure below, WXYZ is a rectangle. Find $\angle m$.

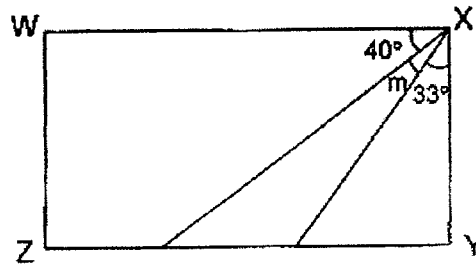

- (1) 7°
- (2) 17°
- (3) 73°
- (4) 107°

- 14 The diagram below is made up of 2 squares and 1 rectangle. Find the length of AB.

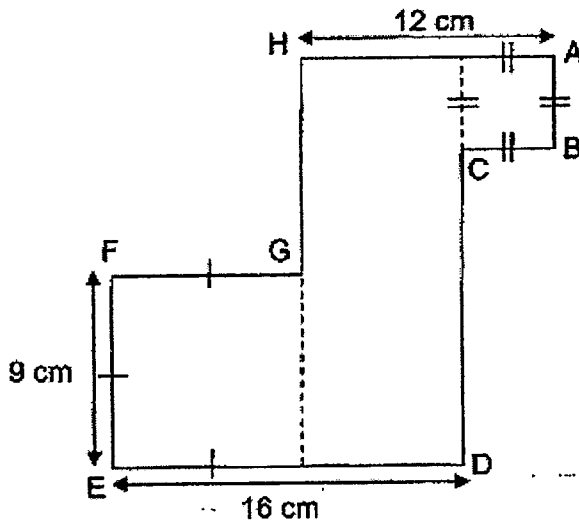

- (1) 5 cm
- (2) 7 cm
- (3) 3 cm
- (4) 4 cm

- 15 The figure is made of 7 small squares. What is the least number of small squares that must be added to make a larger square?

- (1) 5
- (2) 8
- (3) 9
- (4) 16

The square grid below shows some places in a neighbourhood.
Use the diagram to answer Questions 16 and 17.

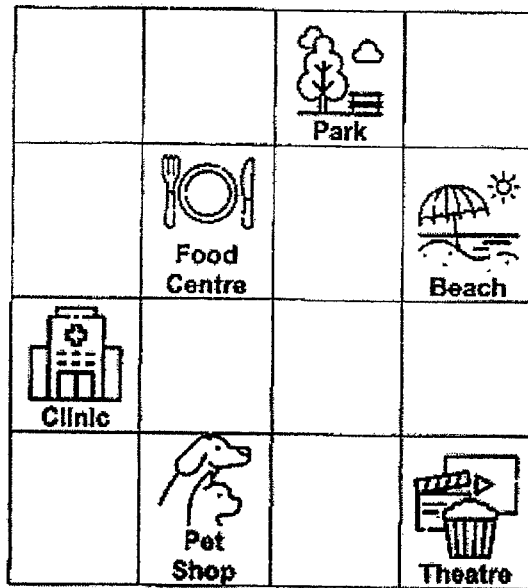

- 16 In what direction is the pet shop from the beach?
- (1) North-east
 - (2) North-west
 - (3) South-east
 - (4) South-west
- 17 Cathy is at the food centre facing west. What will she be facing when she turns 225° in a clockwise direction?
- (1) Beach
 - (2) Clinic
 - (3) Park
 - (4) Theatre
- 18 Amy and Bobby shared a box of chocolates equally between them. After Amy ate 26 pieces of her share and Bobby ate 10 of his, Bobby had three times as many chocolates left as Amy. How many chocolates did Amy have at first?
- (1) 34
 - (2) 36
 - (3) 78
 - (4) 108

- 19 Figure ABCD is a rectangle. $\angle BCE$ is 12° . $\angle DCA$ is 3 times the size of $\angle BCE$. Find $\angle ACE$.

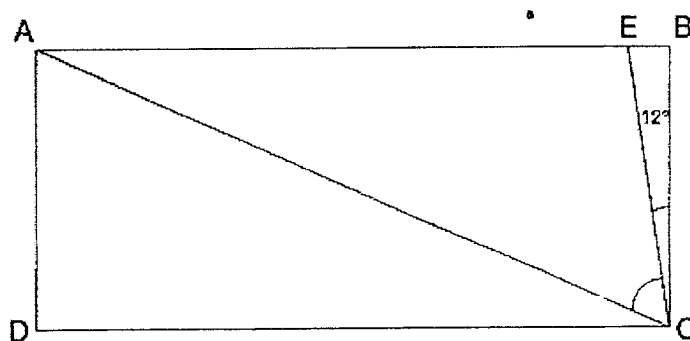

- (1) 36°
(2) 42°
(3) 54°
(4) 78°
- 20 James ran on Monday, Tuesday, Wednesday and Thursday. Each day, he ran 150 m more than the day before. He ran a total of 4100 m for the four days. How far did he run on Monday?
- (1) 800 m
(2) 875 m
(3) 900 m
(4) 1025 m



RED SWASTIKA SCHOOL

2022 MID-YEAR EXAMINATION

MATHEMATICS

Name : _____ ()

Class : Primary 4 / _____

Date : 11 May 2022

BOOKLET B

25 Questions
60 Marks

In this booklet, you should have the following:

- (a) Page 7 to Page 15
- (b) Questions 21 to 45

MARKS

| | OBTAINED | POSSIBLE |
|-----------|----------|----------|
| BOOKLET A | | 40 |
| BOOKLET B | | 60 |
| TOTAL | | 100 |

Parent's Signature : _____

Questions 21 to 40 carry 2 marks each. Show your working clearly in the space below each question and write your answers in the spaces provided. For questions which require units, give your answers in the units stated.

(40 marks)

21 Write fifty-three thousand and twelve in numerals.

Ans: _____

22 What is the product of 473 and 65?

Ans: _____

23 What is the angle of a $\frac{1}{2}$ -turn on a wheel?

Ans: _____

24 Use the given protractor and complete the drawing of $\angle XYZ = 165^\circ$ by labelling the point Z.

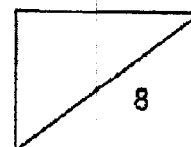
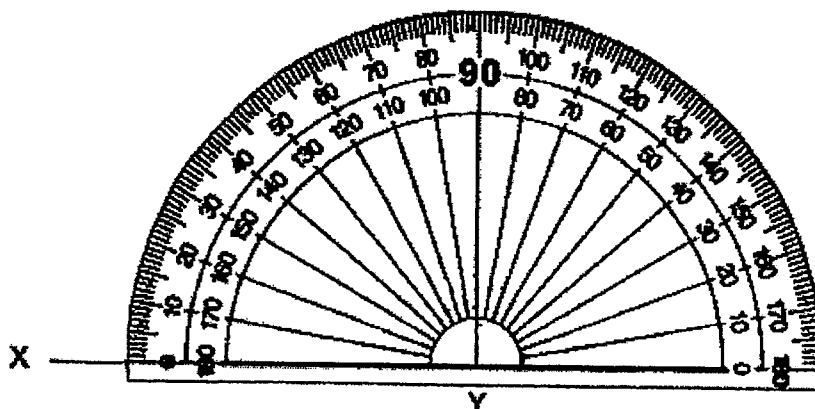

The bar graph below shows the number of tourists who visited the zoo from Monday to Friday.

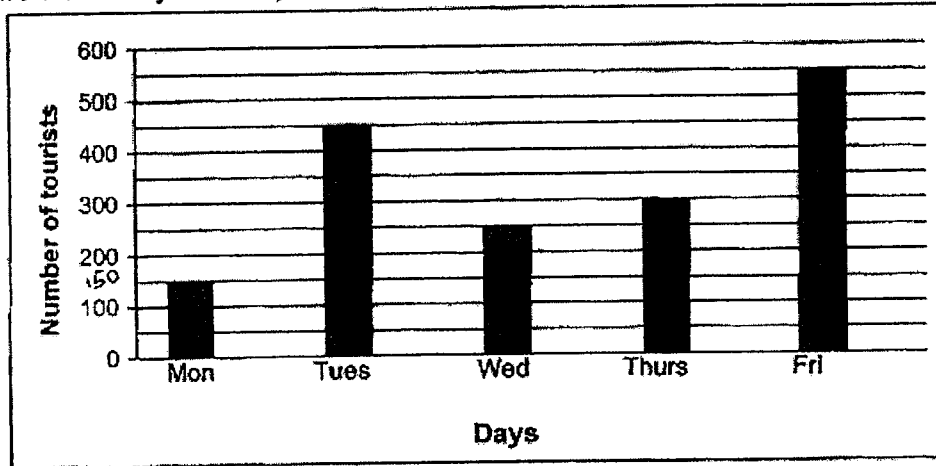

- 25 What was the total number of tourists who visited the zoo over the five days?

Ans: _____

- 26 MNOP is a square. Find $\angle b$.

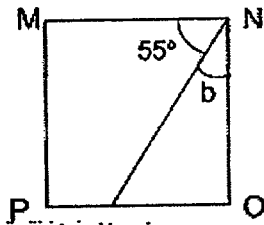

Ans: _____

- 27 Complete drawing a square with the given lines.

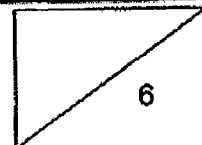
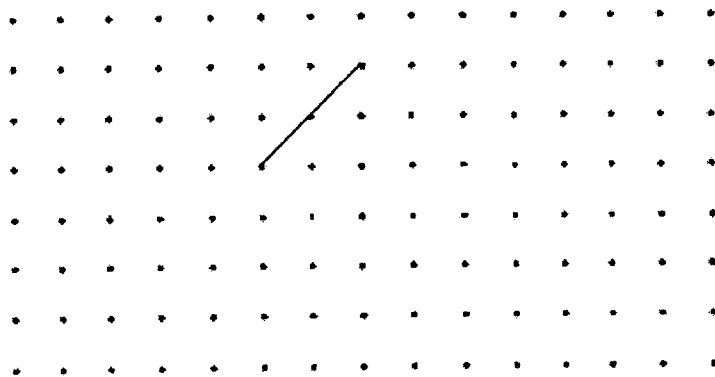

- 28 Four number cards are shown below. Arrange these number cards to form the greatest 4-digit odd number.

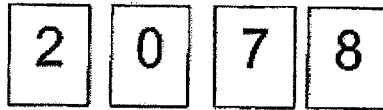

Ans: _____

- 29 Complete the number pattern.

65 621, 55 520, 45 419, _____, 25 217, 15 116

Ans: _____

- 30 Mr Lee bought 5 identical chairs at \$475. Mr Chua bought 8 such chairs from the same shop. How much did Mr Chua pay for the 8 chairs?

Ans: \$ _____

- 31 A number when rounded to the nearest hundred is 5000. What is the smallest possible number?

Ans: _____

- 32 A piece of rope was 2 m long and a small piece measuring 65 cm was cut from it. The remaining rope was cut into 5 equal pieces. What is the length of each of the 5 pieces?

Ans: _____ cm

9

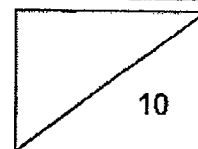

Use the following diagram to answer Questions 33 to 35.

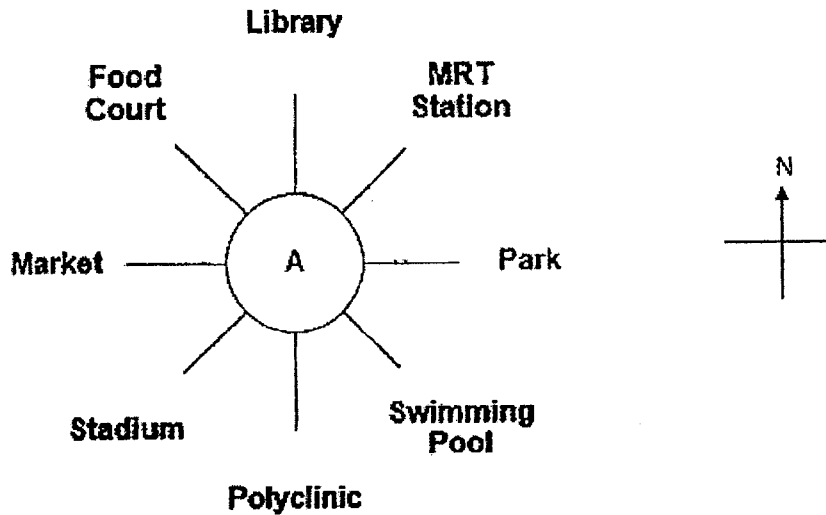

- 33 Eileen is standing at the point marked A in the diagram above. She is facing the Food Court. Where will she be facing when she makes a half-turn in a clockwise direction?

Ans: _____

- 34 Florence is standing at the point marked A in the diagram above. She is facing the Park. She turns in an anti-clockwise direction and then faces the Polyclinic. What angle has she turned?

Ans: _____°

- 35 Gary was standing at the point marked A in the diagram above. After making a $\frac{1}{4}$ -turn in an anticlockwise direction, Gary found himself facing the Library. Where was he facing at first?

Ans: _____

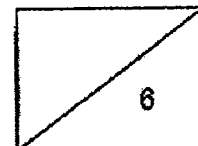

- 36 The figure below is made up of a square ABCD and a rectangle CEFG. $\angle XCD$ is 31° . Find $\angle BCG$.

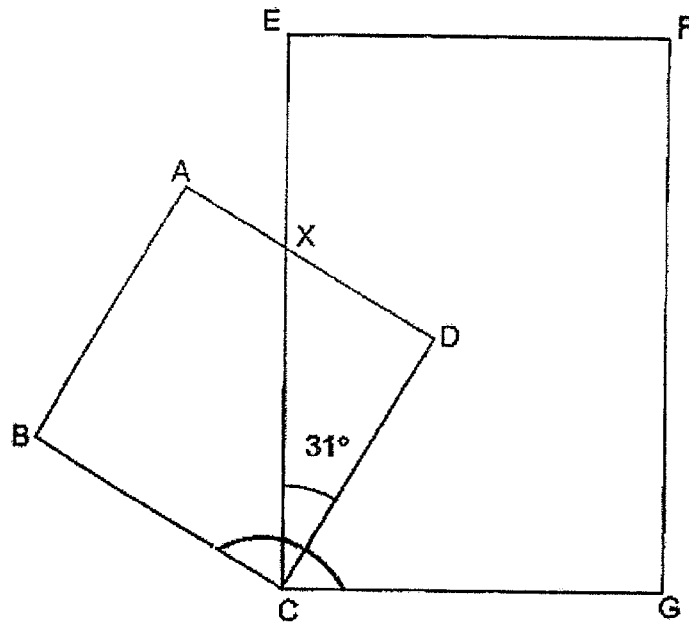

Ans: _____ $^\circ$

- 37 A rectangular piece of paper was folded on both ends to form the shape shown below. Given that the breadth of the rectangle was 14 cm, find the length of the rectangular piece of paper before it was folded?

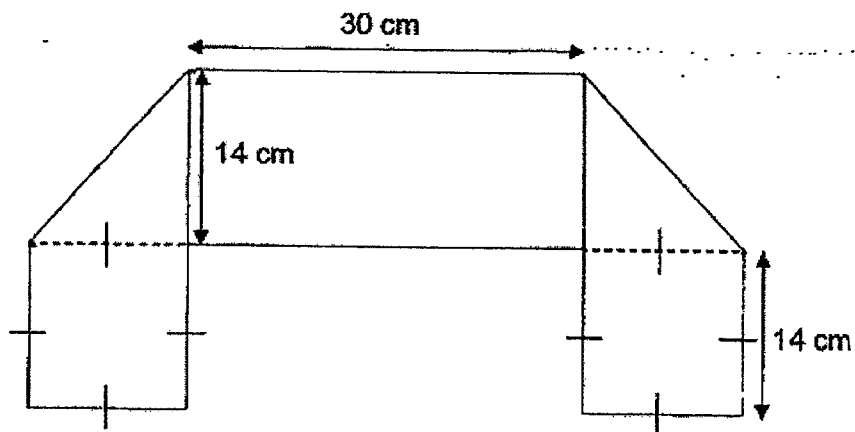

Ans: _____ cm

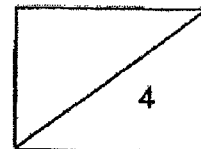

- 38 A packet of cookies cost \$9.50. A box of ice-cream cost \$4.85 more than a packet of cookies. Rachel bought a packet of cookies and a box of ice-cream. She paid the cashier \$50. How much change did she receive?

Ans: \$ _____

- 39 The length of a rectangular room is 16 m. Its breadth is half its length. Find the perimeter of the rectangular room.

Ans: _____ m

- 40 This year, Sophia's age is a 2-digit number which is a multiple of 4. Next year, her age will be a multiple of 9. If Sophia is less than 50 years old, how old is she this year?

Ans: _____

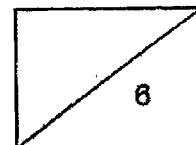

Questions 41 to 45 carry 4 marks each. Show your working clearly in the space below each question and write your answers in the spaces provided.
(20 marks)

- 41 Mr Pang bought 26 baskets of durians. Each basket contained 49 durians. He sold 147 durians. Then he packed the remaining durians equally into 7 crates. How many durians were there in each crate?

Ans: _____ [4]

- 42 3 l of water was poured into 2 empty buckets. After pouring, Bucket A contained 90 ml more water than Bucket B. How much water was there in Bucket B? Give your answer in litres and millilitres.

Ans: _____ [4]

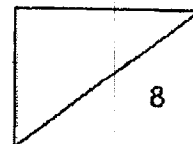

- 43 For every 2 marbles that Ivan buys, John buys 3 marbles more than him. They buy 294 marbles altogether. How many marbles does Ivan buy?

Ans: _____ [4]

- 44 Alex, Bryan and Charles had some stickers. Alex and Bryan had a total of 7832 stickers. Charles and Alex had a total of 4342 stickers. Bryan had 3 times as many stickers as Charles. How many stickers did Alex have?

Ans: _____ [4]

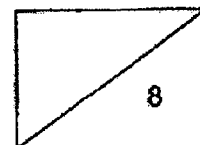

- 45 The total mass of Jane, Kenny and Lisa is 178 kg. Kenny is 54 kg heavier than Lisa. Jane is twice as heavy as Lisa. Find Kenny's mass.

Ans: _____ [4]

End of Paper

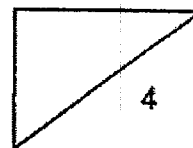

SCHOOL : RED SWASTIKA PRIMARY SCHOOL
 LEVEL : PRIMARY 4
 SUBJECT : MATHEMATICS
 TERM : 2022 SA1

PAPER 1 BOOKLET A

| | | | | | | | | | |
|------|-----|-----|-----|-----|-----|-----|-----|-----|-----|
| Q 1 | Q2 | Q3 | Q4 | Q5 | Q6 | Q7 | Q8 | Q9 | Q10 |
| 2 | 4 | 3 | 3 | 2 | 3 | 3 | 2 | 2 | 4 |
| Q 11 | Q12 | Q13 | Q14 | Q15 | Q16 | Q17 | Q18 | Q19 | Q20 |
| 2 | 4 | 2 | 1 | 3 | 4 | 4 | 1 | 2 | 1 |

PAPER 1 BOOKLET B

| | |
|------|----------------------|
| Q21) | 53012 |
| Q22) | 30745 |
| Q23) | 180° |
| Q24) | |
| Q25) | 1700 |
| Q26) | $90 - 55 = 35^\circ$ |
| Q27) | |
| Q28) | 8207 |
| Q29) | 35318 |
| Q30) | \$760 |

| | |
|------|--|
| Q31) | 4950 |
| Q32) | 27cm |
| Q33) | swimming pool |
| Q34) | 270° |
| Q35) | Park |
| Q36) | $59 + 59 + 31 = 149^\circ$ |
| Q37) | 86cm |
| Q38) | 26.15 |
| Q39) | $16 \times 3 = 48m$ |
| Q40) | 44 |
| Q41) | $26 \times 49 = 1274$ $1274 - 147 = 1127$ $1127 \div 7 = 161$ |
| Q42) | $3l = 3000ml$ $3000 - 90 = 2910$ $2910 \div 2 = 1455$ $1455 = 1l455ml$ |
| Q43) | $2 + 2 + 3 = 7$ $294 \div 7 = 42$ $42 \times 2 = 84$ |
| Q44) | $7832 - 4342 = 3490$ $3490 \div 2 = 1745$ $7832 - 1745 = 6087$ $6087 - 3490 = 2597$ |
| Q45) | $178 - 54 = 124$ $124 \div 4 = 31$ $31 + 54 = 85kg$ |